

护线圈 56

玻璃门嵌条 55

门封条 54

门玻璃 53

门封条 52

玻璃门拉手 51

上面板 50

后支柱 49

中支柱 48

贴片LED灯 47

下蒸发器 46

蒸发器网罩 45

下接水盒右侧板 44

下接水盒立柱 43

下接水盒左侧板 42

漏水管 41

后盖板 40

库温探头 39

化霜探头 38

主板 37

电子温控器 36

电子镇流器 35

电源线 34

温控器盒 33

温控器盒面板 32

干燥过滤器 31

冷凝器 30

风扇电机 29

压缩机 28

压板 27

水槽 26

压缩机底板 25

1 灯罩-加工

2 上蒸发器

3 上接水盒左侧板

4 上接水盒立柱

5 上接水盒右侧板

6 密封条

7 弧形玻璃

8 装饰帽

9 左侧玻璃

10 左侧板

11 左侧泡沫

12 左内侧板

13 螺丝软塞子

14. 右侧玻璃

15. 右内侧板

16. 右侧板

17 底座组件(发泡)

18 不锈钢条

19 前支柱

20 黑底可调整脚

21 脚架左右支撑

22 脚架横档

23 脚轮(无刹)

24 脚轮(带刹)

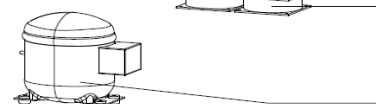
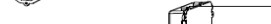
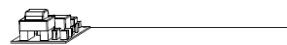
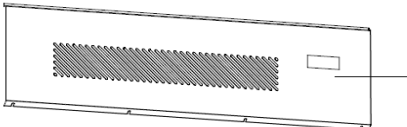
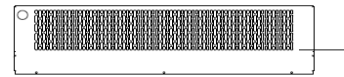
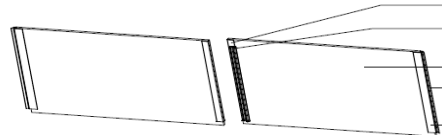
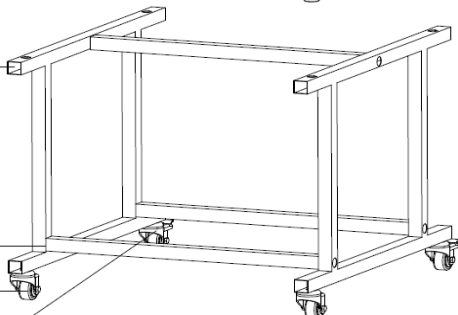
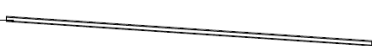
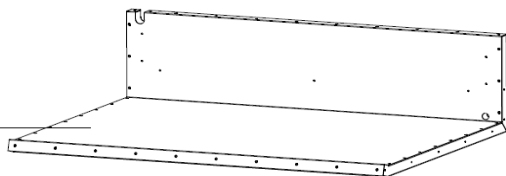
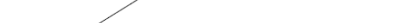
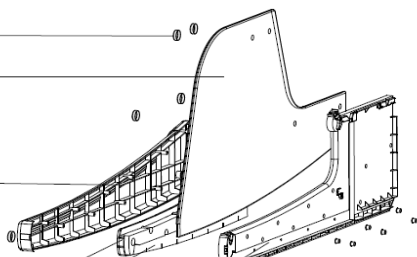
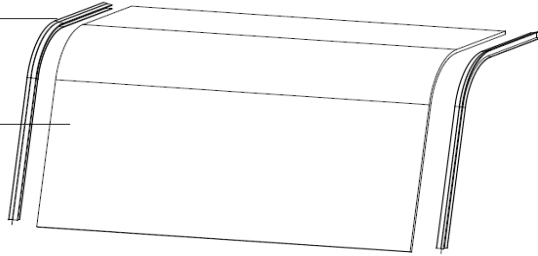

PARTS LIST OF RTW-255L

| NO. | Item number | Parts Name |
|-----|-----------------|-------------------------------------|
| 1 | 1.1.C.C72.01.05 | Light holder |
| 2 | 1.1.A.A10.37.A1 | Top evaporator |
| 3 | 1.1.C.C70.27 | Left board of upper water receiver |
| 4 | 1.1.C.C72.02.03 | Upper water receiver |
| 5 | 1.1.C.C70.28 | Right board of upper water receiver |
| 6 | 1.1.C.C70.16 | Side glass sealing strip |
| 7 | 1.1.E.E2.06.20 | Curved glass |
| 8 | 1.1.B.B29.35 | Decorative cover |
| 9 | 1.1.E.E2.04.18 | Left glass |
| 10 | 1.1.C.C70.19 | Left external panel |
| 11 | 1.1.D.D08.02.24 | Left polyfoam |
| 12 | 1.1.C.C70.21 | Left internal panel |
| 13 | 1.1.C.C46.02.18 | Soft stopper |
| 14 | 1.1.E.E2.06.19 | Right glass |
| 15 | 1.1.C.C70.22 | Right internal panel |
| 16 | 1.1.C.C70.20 | Right external panel |
| 17 | 1.1.B.B38.08 | Base component |
| 18 | 1.1.B.B03.16 | Decorative strip |
| 19 | 1.1.C.C70.02.01 | Front frame |
| 20 | 1.1.C.C32.18 | Adjustable feet |
| 21 | 1.1.B.B36.14 | Bracket |
| 22 | 1.1.B.B38.11 | Crosspiece of bracket |
| 23 | 1.1.B.B10.95 | Wheel |
| 24 | 1.1.B.B10.23 | Wheel with brake |
| 25 | 1.1.B.B38.07.A0 | Compressor holder |
| 26 | 1.1.C.C70.11 | Water receiver |
| 27 | 1.1.B.B36.13 | Press plate |
| 28 | 1.1.A.A02.82 | Compressor |

| NO. | Item number | Parts Name |
|-----|--------------------|-------------------------------------|
| 29 | 1.1.A.A03.01.31 | Fan motor |
| 30 | 1.1.A.A09.47 | Condenser |
| 31 | 1.1.A.A04.01 | Dry filter |
| 32 | 1.1.C.C22.07.A1 | Circuit board box |
| 33 | 1.1.C.C21.03.A1 | Cover board |
| 34 | 1.1.A.A08.02.87 | Power cord |
| 35 | 1.1.A.A01.10.30 | Transformer of LED |
| 36 | 1.1.A.A17.06.04 | Temperature Display |
| 37 | 1.1.A.A17.01.01 | Main Circuit Board |
| 38 | 1.1.L.L24.04.11 | Defrost probe |
| 39 | 1.1.L.L24.04.10 | Temperature probe |
| 40 | 1.1.B.B38.06 | Back cover |
| 41 | 1.1.C.C45.03.15 | Drain pipe |
| 42 | 1.1.C.C70.29 | Under water receiver |
| 43 | 1.1.C.C72.02.04 | Left board of under water receiver |
| 44 | 1.1.C.C70.30 | Right board of under water receiver |
| 45 | 1.1.B.B38.12 | Mesh enclosure |
| 46 | 1.1.A.A10.38.A1 | Evaporator |
| 47 | 1.1.A.A01.14.88.A1 | LED illumination |
| 48 | 1.1.C.C72.01.03 | Middle pillar |
| 49 | 1.1.C.C72.01.04 | Back pillar |
| 50 | 1.1.B.B38.05 | Top panel |
| 51 | 1.1.C.C12.19.A0 | Door knob |
| 52 | 1.1.C.C87.09 | Door seal strip1 |
| 53 | 1.1.E.E2.04.24.A1 | Glass door |
| 54 | 1.1.C.C70.36 | Door seal strip2 |
| 55 | 1.1.B.B36.17 | Door frame |
| 56 | 1.1.C.C70.34 | Wire ring |